

REVISIONS

REV.	DESCRIPTION	ECO	DATE	APPROVED
1	INITIAL RELEASE	IR	04/16/13	P.T

THIS DRAWING HAS BEEN GENERATED BY A CAD SYSTEM. CHANGES SHALL ONLY BE INCORPORATED AS DIRECTED BY THE DESIGN ACTIVITY. DO NOT REVISE MANUALLY.

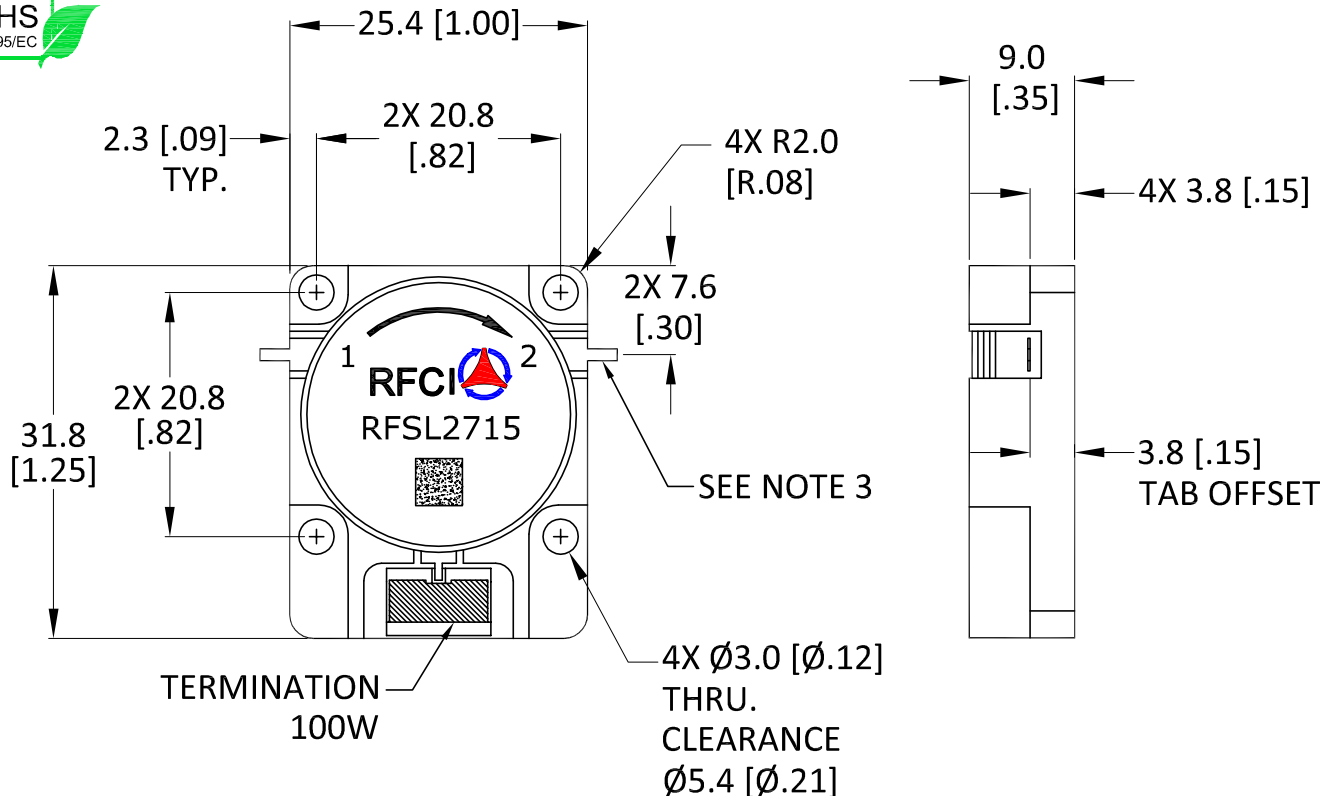

Specifications

Parameter	Minimum	Typical	Maximum
Frequency Range (MHz)	2130		2280
Insertion Loss (dB)		< .20	.30
Isolation (dB)	22	> 25	
Return Loss (dB)	22	> 25	
FWD IMD: 2T at 37W per T 5MHz Spacing (dBc)		75	

Power & Temperature Ratings

Parameter	Maximum
Forward PWR Peak/AVG	1000/200 Watts
Reverse Power CW	100 Watts
Termination Rating (See Note 2.)	100 Watts
Operating Temperature	-40 to +85° C
Storage Temperature	-40 to +95° C

Notes:

1. Typical Values Represent Mid-Band Performance @ +23 °C.
2. Isolator Flange held to +85°C; 30 Min. maximum Duration.
3. Tab dims: 1.0[.04]Width x 2.5[.10]Length x .20[.008]Thick

CW 100W ISOLATOR MODEL: RFSL2715

<p>UNLESS OTHERWISE SPECIFIED ALL DIMENSIONS ARE IN MILLIMETERS (INCHES):</p> <p>TOLERANCES ARE:</p> <table border="0"> <tr> <td>1 PLACE DECIMAL ±.2 [±.01]</td> <td>ANGULAR: ±1.0°</td> </tr> <tr> <td>2 PLACE DECIMAL ±.10 [±.004]</td> <td>SURFACE ROUGHNESS 16/</td> </tr> </table> <p>REMOVE ALL BURRS AND BREAK SHARP EDGES. SURFACE TEXTURE TO BE IN ACCORDANCE WITH LATEST ANSI B46.1 DIMENSIONING & TOLERANCING IN ACCORDANCE WITH LATEST ANSI Y14.5</p> <p>PROPRIETARY NOTE: "THE INFORMATION CONTAINED ON THIS DOCUMENT IS CONSIDERED TO BE CONFIDENTIAL MATERIAL PROPRIETARY TO RF CIRCULATOR ISOLATOR Inc. (RFCI) AND IS PROVIDED SOLELY FOR INFORMATION PURPOSES. THIS INFORMATION SHALL NOT BE USED BY ANYONE OTHER THAN RFCI TO DESIGN OR CONSTRUCT ANY OF THE ITEMS DEPICTED, NOR SHALL IT BE DISCLOSED, DUPLICATED, OR COPIED FOR ANY PURPOSE, NOR MADE AVAILABLE TO ANY THIRD PARTY WITHOUT THE PRIOR WRITTEN CONSENT OF A RFCI OFFICIAL."</p>	1 PLACE DECIMAL ±.2 [±.01]	ANGULAR: ±1.0°	2 PLACE DECIMAL ±.10 [±.004]	SURFACE ROUGHNESS 16/	<p>THIRD ANGLE PROJECTION</p>																
	1 PLACE DECIMAL ±.2 [±.01]	ANGULAR: ±1.0°																			
2 PLACE DECIMAL ±.10 [±.004]	SURFACE ROUGHNESS 16/																				
<p>APPROVALS</p> <table border="1"> <thead> <tr> <th>APPROVALS</th> <th>DATE</th> </tr> </thead> <tbody> <tr> <td>DRAWN BY: HV</td> <td>04/13/13</td> </tr> <tr> <td>CHECKED BY: P.T</td> <td>04/14/13</td> </tr> <tr> <td>DESIGN BY: P.T</td> <td>12/12/12</td> </tr> <tr> <td>ENGINEER BY: P.T</td> <td>12/12/12</td> </tr> <tr> <td>MFG. ENGR. L.T</td> <td>04/15/13</td> </tr> <tr> <td>Q.A.</td> <td></td> </tr> <tr> <td>PROG. MGMT/MKT</td> <td></td> </tr> </tbody> </table>	APPROVALS	DATE	DRAWN BY: HV	04/13/13	CHECKED BY: P.T	04/14/13	DESIGN BY: P.T	12/12/12	ENGINEER BY: P.T	12/12/12	MFG. ENGR. L.T	04/15/13	Q.A.		PROG. MGMT/MKT		<p>OUTLINE/SPECS</p> <table border="1"> <tr> <td>SIZE A</td> <td>CAGE NO.</td> <td>DWG NO. SL2715-OS</td> <td>REV. 1</td> </tr> </table>	SIZE A	CAGE NO.	DWG NO. SL2715-OS	REV. 1
APPROVALS	DATE																				
DRAWN BY: HV	04/13/13																				
CHECKED BY: P.T	04/14/13																				
DESIGN BY: P.T	12/12/12																				
ENGINEER BY: P.T	12/12/12																				
MFG. ENGR. L.T	04/15/13																				
Q.A.																					
PROG. MGMT/MKT																					
SIZE A	CAGE NO.	DWG NO. SL2715-OS	REV. 1																		
<p>DO NOT SCALE DRAWING</p>	<p>SCALE: FULL</p>	<p>SHEET 1 OF 1</p>																			