

REVISIONS

REV.	DESCRIPTION	ECO	DATE	APPROVED
1	INITIAL RELEASE	IR	04/18/13	P.T

THIS DRAWING HAS BEEN GENERATED BY A CAD SYSTEM. CHANGES SHALL ONLY BE INCORPORATED AS DIRECTED BY THE DESIGN ACTIVITY. DO NOT REVISE MANUALLY.

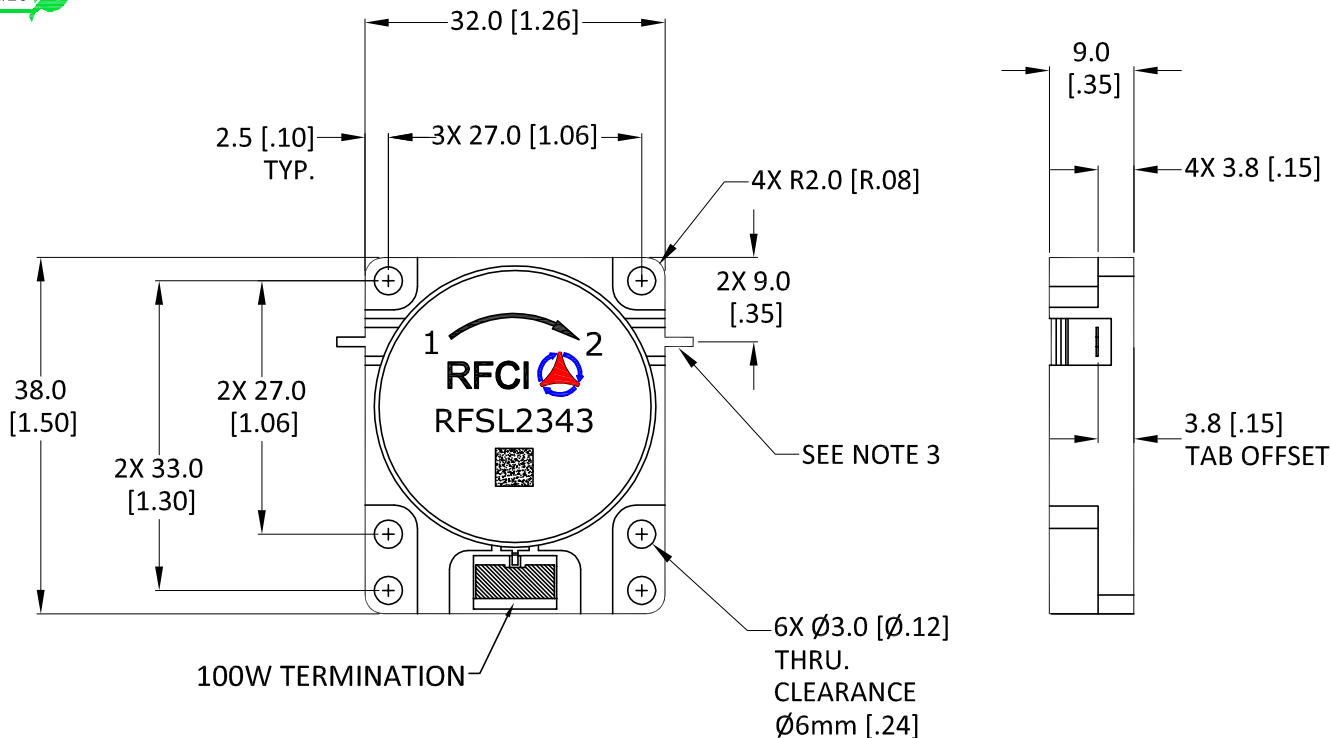

Specifications

Parameter	Minimum	Typical	Maximum
Frequency Range (MHz)	1160		1220
Insertion Loss (dB)		< .20	.30
Isolation (dB)	22	> 25	
Return Loss (dB)	22	> 25	

Power & Temperature Ratings

Parameter	Maximum
Forward PWR Peak/AVG	1000/200 Watts
Reverse Power CW	100 Watts
Termination Rating (See Note 2)	100 Watts
Operating Temperature	-40 to +85° C
Storage Temperature	-40 to +95° C

Notes:

1. Typical Values Represent Mid-Band Performance @ +23 °C.
2. Isolator Flange held to +85°C; 30 Min. maximum Duration.
3. Tab dimensions: 1.00[.039]Width x 3.0[.12]Length x .20[.008]Thick

CW 100W ISOLATOR MODEL: RFSL2343

<p>UNLESS OTHERWISE SPECIFIED ALL DIMENSIONS ARE IN MILLIMETERS (INCHES):</p> <p>TOLERANCES ARE:</p> <p>1 PLACE DECIMAL ±.2 [±.01] ANGULAR: ±1.0° 2 PLACE DECIMAL ±.10 [±.004] SURFACE ROUGHNESS 16/</p> <p>REMOVE ALL BURRS AND BREAK SHARP EDGES. SURFACE TEXTURE TO BE IN ACCORDANCE WITH LATEST ANSI B46.1 DIMENSIONING & TOLERANCING IN ACCORDANCE WITH LATEST ANSI Y14.5</p> <p>PROPRIETARY NOTE: "THE INFORMATION CONTAINED ON THIS DOCUMENT IS CONSIDERED TO BE CONFIDENTIAL MATERIAL PROPRIETARY TO RF CIRCULATOR ISOLATOR Inc. (RFCI) AND IS PROVIDED SOLELY FOR INFORMATION PURPOSES. THIS INFORMATION SHALL NOT BE USED BY ANYONE OTHER THAN RFCI TO DESIGN OR CONSTRUCT ANY OF THE ITEMS DEPICTED, NOR SHALL IT BE DISCLOSED, DUPLICATED, OR COPIED FOR ANY PURPOSE, NOR MADE AVAILABLE TO ANY THIRD PARTY WITHOUT THE PRIOR WRITTEN CONSENT OF A RFCI OFFICIAL."</p> <p>DO NOT SCALE DRAWING</p>		<p>THIRD ANGLE PROJECTION</p> <table border="1"> <thead> <tr> <th>APPROVALS</th> <th>DATE</th> </tr> </thead> <tbody> <tr> <td>DRAWN BY: HV</td> <td>04/14/13</td> </tr> <tr> <td>CHECKED BY: P.T</td> <td>04/15/13</td> </tr> <tr> <td>DESIGN BY: P.T</td> <td>01/17/13</td> </tr> <tr> <td>ENGINEER BY: P.T</td> <td>01/17/13</td> </tr> <tr> <td>MFG. ENGR. L.T</td> <td>04/17/13</td> </tr> <tr> <td>Q.A.</td> <td></td> </tr> <tr> <td>PROG. MGMT/MKT</td> <td></td> </tr> </tbody> </table>	APPROVALS	DATE	DRAWN BY: HV	04/14/13	CHECKED BY: P.T	04/15/13	DESIGN BY: P.T	01/17/13	ENGINEER BY: P.T	01/17/13	MFG. ENGR. L.T	04/17/13	Q.A.		PROG. MGMT/MKT		<p>RFCI </p> <p>OUTLINE/SPECS</p>	
APPROVALS	DATE																			
DRAWN BY: HV	04/14/13																			
CHECKED BY: P.T	04/15/13																			
DESIGN BY: P.T	01/17/13																			
ENGINEER BY: P.T	01/17/13																			
MFG. ENGR. L.T	04/17/13																			
Q.A.																				
PROG. MGMT/MKT																				
SIZE A	CAGE NO.	DWG NO. SL2342-OS	REV. 1																	
SCALE: FULL		SHEET 1 OF 1																		